

USER MANUAL

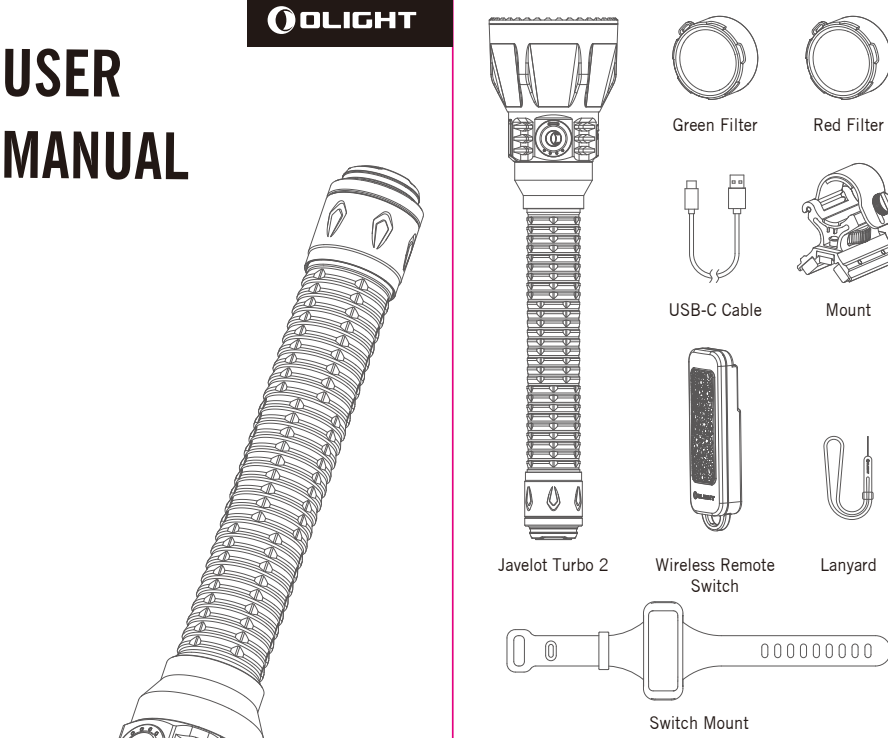

Table A-1: USB-C Charging Cable	
Charge type	USB-A to USB-C cable
Cable length	0.8 m
Input	5V / 7.2 A
Time to fully charge	About 4.5 hours

MCC3 Cable (not included)	
Cable length	0.5 m
Input	USB Type-A DC 5V / 2.1 A
Output	OCVCV 5V / 2 A
Time to fully charge	About 5 hours

Javelot (Turbo) 2 KIT

Figure 15

Pair the flashlight with a new switch

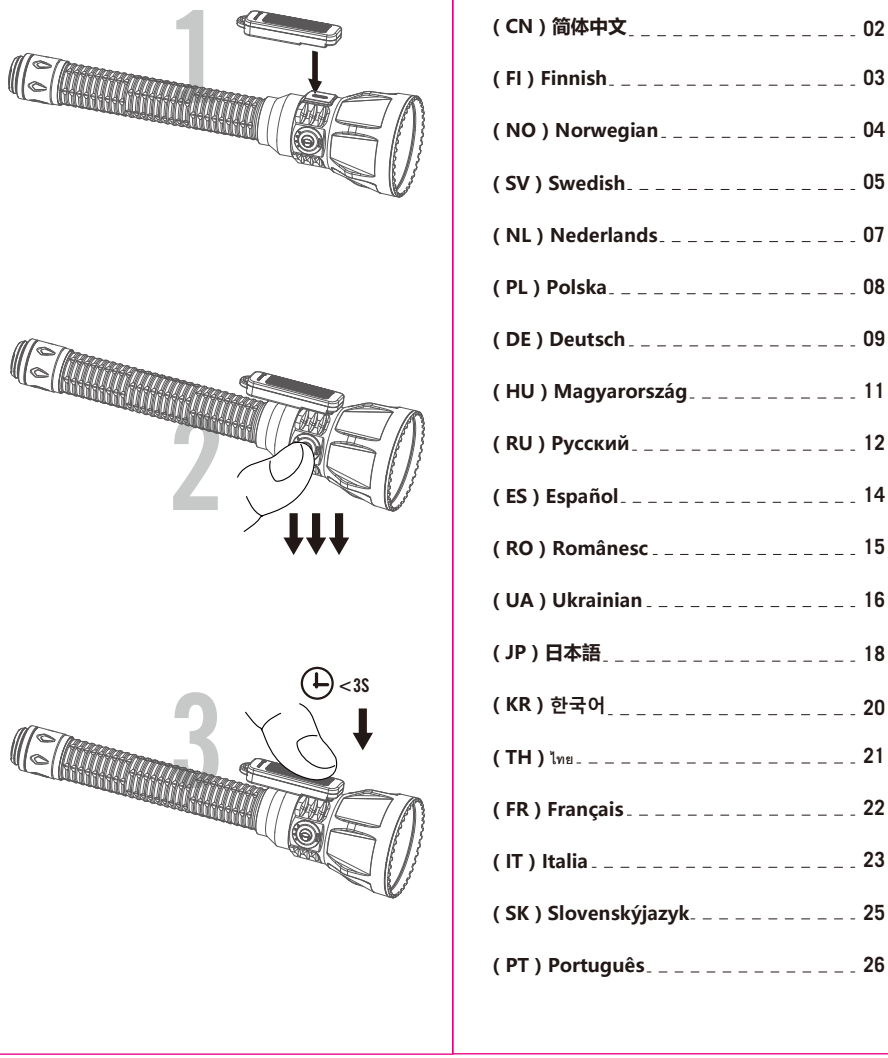

CONTENTS

(N) English	01
(E) 简体中文	02
(F) Finnish	03
(NO) Norwegian	04
(SV) Swedish	05
(NL) Nederlands	07
(PL) Polska	08
(DE) Deutsch	09
(HU) Magyarország	11
(RU) Русский	12
(ES) Español	14
(RO) Românească	15
(UA) Ukrainian	16
(JP) 日本語	17
(KR) 한국어	20
(TH) ไทย	21
(FR) Français	22
(IT) Italia	23
(SK) Slovenský jazyk	24
(PT) Português	26

(HU) Magyarország	27
(IT) Italiano	31
(FR) Français	33
(SK) Slovenský jazyk	34
(PT) Português	35
(RU) Русский	37
(ES) Español	41
(RO) Românească	43
(UA) Ukrainian	44
(JP) 日本語	45
(KR) 한국어	48
(TH) ไทย	49
(NL) Nederlands	53
(PL) Polska	54
(DE) Deutsch	55
(HU) Magyarország	57

(NL) Nederlands	59
(PL) Polska	60
(DE) Deutsch	61
(HU) Magyarország	63
(RU) Русский	65
(ES) Español	69
(RO) Românească	71
(UA) Ukrainian	72
(JP) 日本語	73
(KR) 한국어	76
(TH) ไทย	77
(FR) Français	79
(IT) Italia	81
(SK) Slovenský jazyk	82
(PT) Português	83

(PT) Português	85
(RU) Русский	87
(ES) Español	91
(RO) Românească	93
(UA) Ukrainian	94
(JP) 日本語	95
(KR) 한국어	98
(TH) ไทย	99
(NL) Nederlands	103
(PL) Polska	104
(DE) Deutsch	105
(HU) Magyarország	107

(NL) Nederlands	111
(PL) Polska	112
(DE) Deutsch	113
(HU) Magyarország	115
(RU) Русский	117
(ES) Español	121
(RO) Românească	123
(UA) Ukrainian	124
(JP) 日本語	125
(KR) 한국어	128
(TH) ไทย	129
(FR) Français	131
(IT) Italia	133
(SK) Slovenský jazyk	134
(PT) Português	135

Figure 1

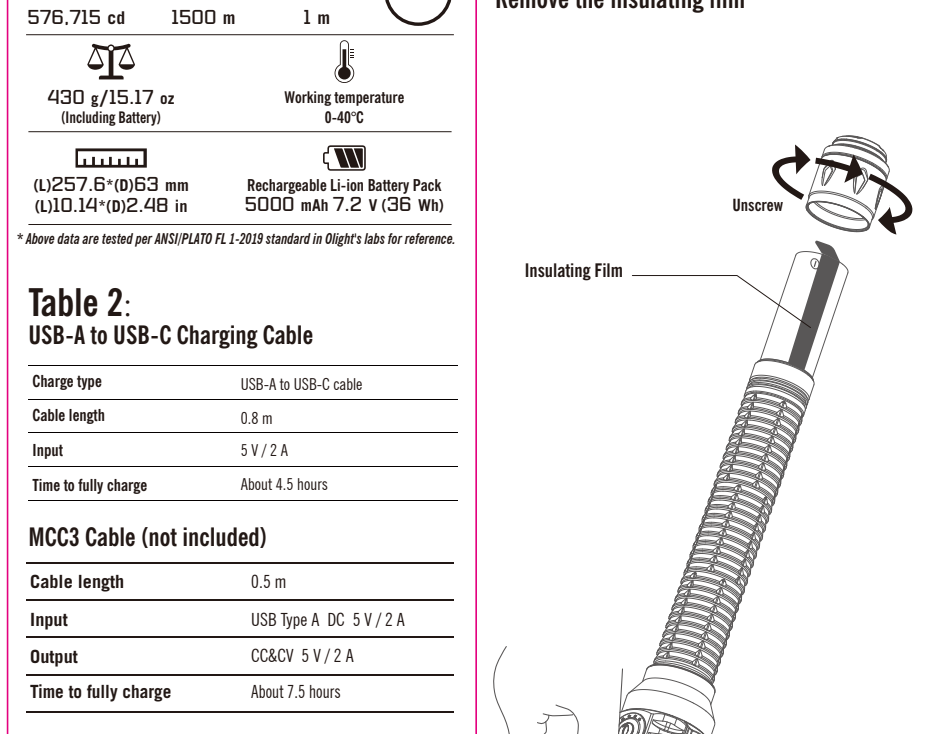

Wireless Remote Switch	
FEATURES	SPECIFICATIONS
Operation frequency	2.4GHz: 242MHz-2480MHz
Maximum Output Power	2.4GHz: 100mW
Maximum control distance	8 m
Dimensions	1.5 * 3.5 * 1.5 cm (L * W * H)
Weight	13.2 g / 0.47 oz
Battery	3.1V 25 mAh (CR 2032)
Waterproof level	IP68
Max impact resistance	1.2 m
Input	OCVCV DC 5V / 2A

Figure 16

Remove the insulating film



Figure 2

Charging

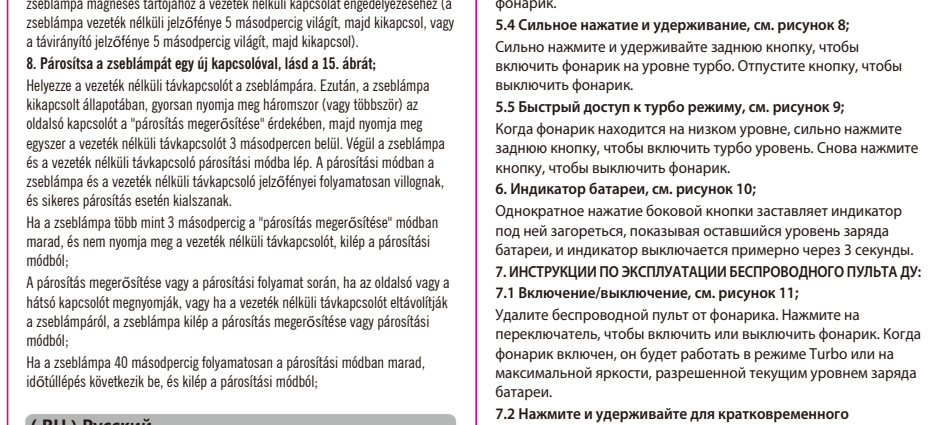

Figure 3

Turn on/off

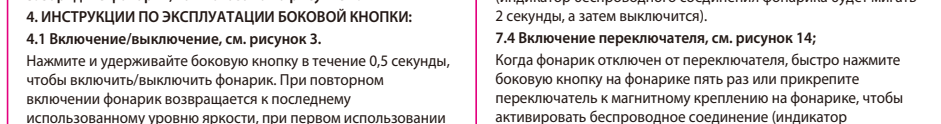

Figure 4

Change the brightness

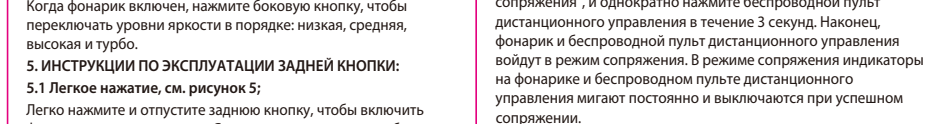

Figure 5

Lightly press and hold to activate the low light mode, or turn ON/OFF the flashlight

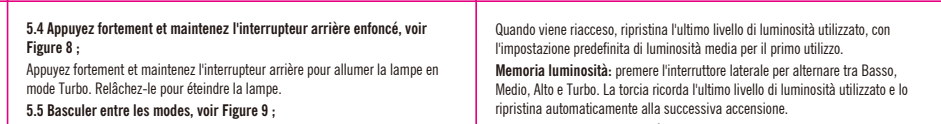

Figure 6

Hard press to activate the Turbo light output, flashlight ON/OFF

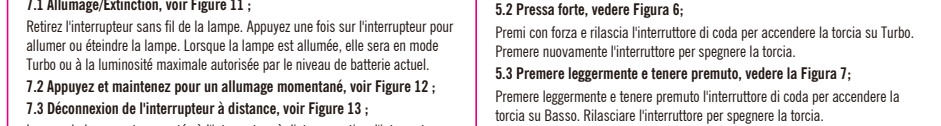

Figure 7

Lightly press and hold to maintain the low light mode, release to turn off the light

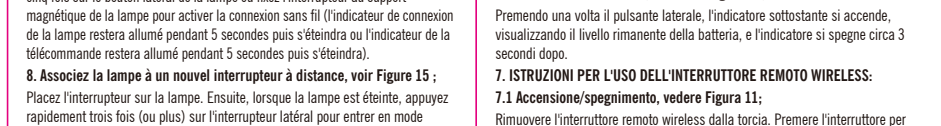

Figure 8

Hard press and hold to maintain the Turbo light output, release to turn off the light

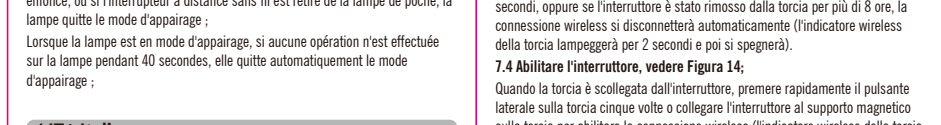

Figure 9

Press again to switch to Turbo when the flashlight is at a low brightness level.

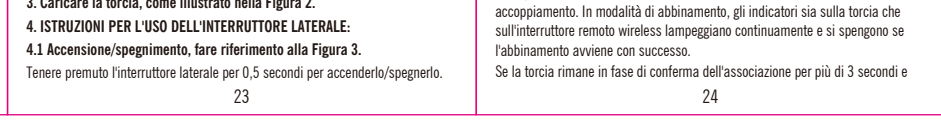

Figure 10

Press and hold

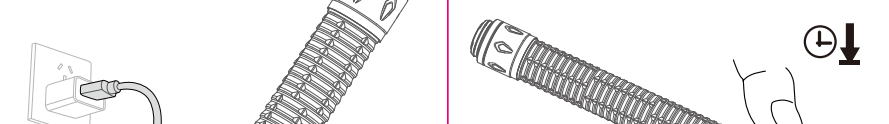

Figure 11

Press and hold for Momentary On

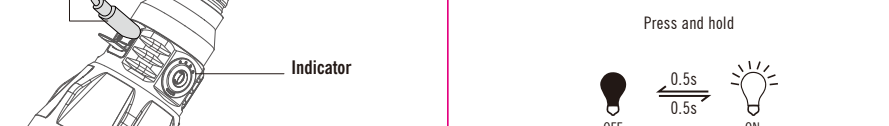

Figure 12

Press and hold for Momentary On

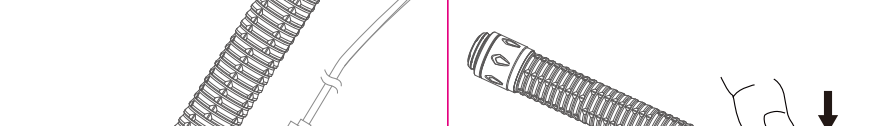

Figure 13

Enable the switch

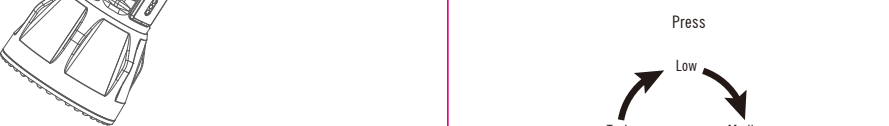

Figure 14

Press and hold

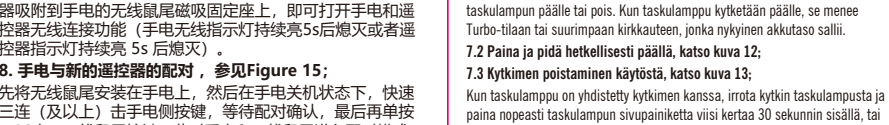

Figure 15

Press and hold

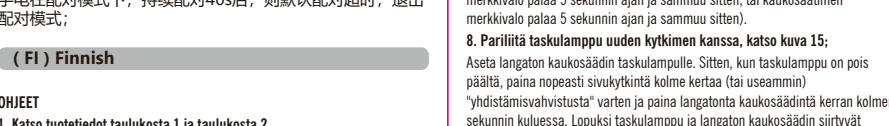

Figure 16

Press and hold

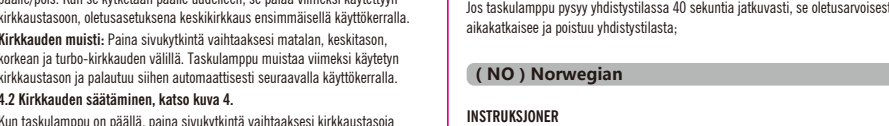

Figure 17

Press and hold

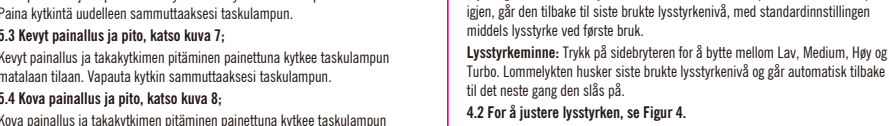

Figure 18

Press and hold



Figure 19

Press and hold

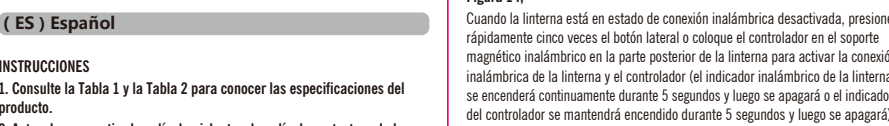

Figure 20

Press and hold

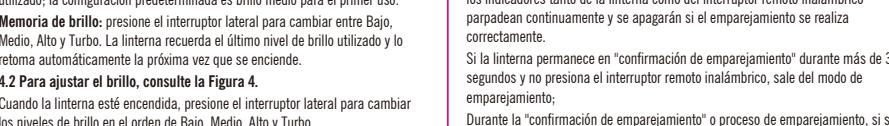

Figure 21

Press and hold

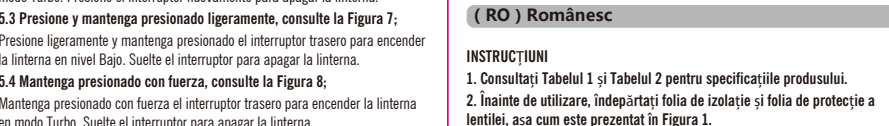

Figure 22

Press and hold

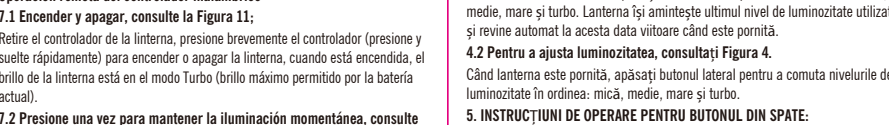

Figure 23

Press and hold

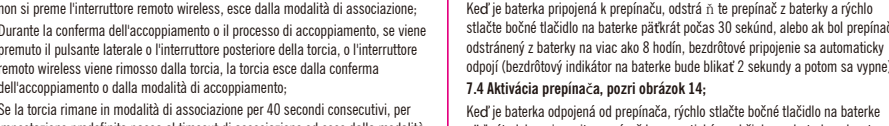

Figure 24

Press and hold

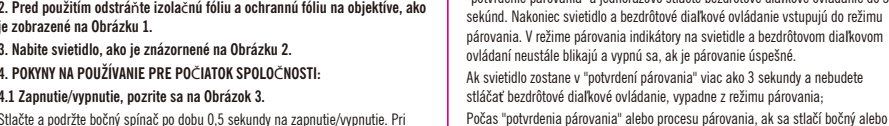

Figure 25

Press and hold



Figure 26

Press and hold

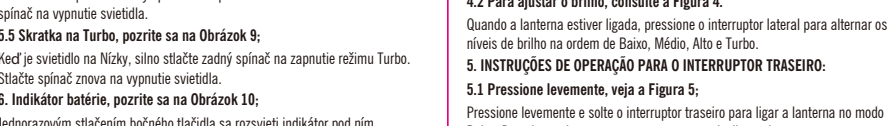

Figure 27

Press and hold

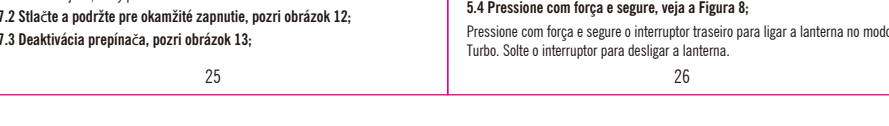

Figure 28

Press and hold

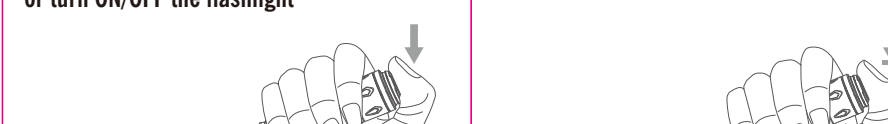

Figure 29

Press and hold

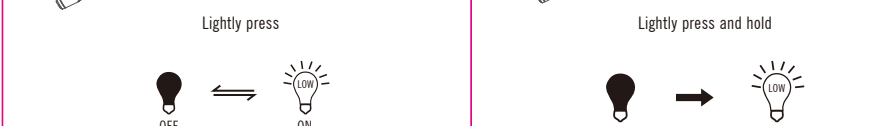

Figure 30

Press and hold



Figure 31

Press and hold

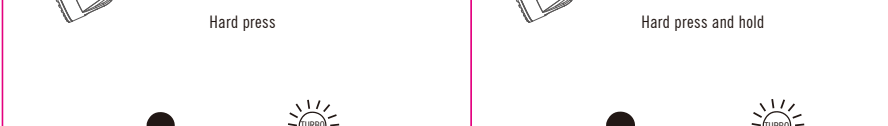

Figure 32

Press and hold

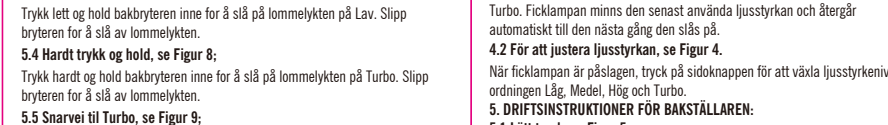

Figure 33

Press and hold

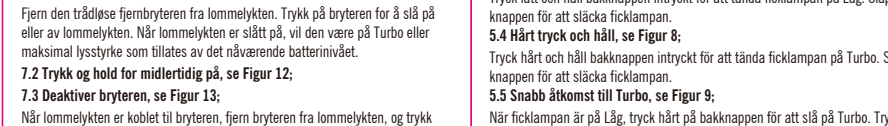

Figure 34

Press and hold

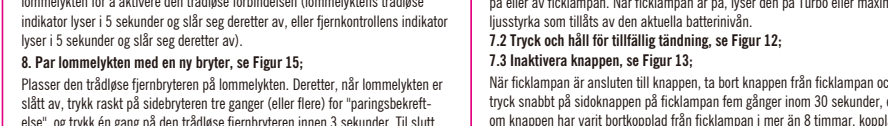

Figure 35

Press and hold

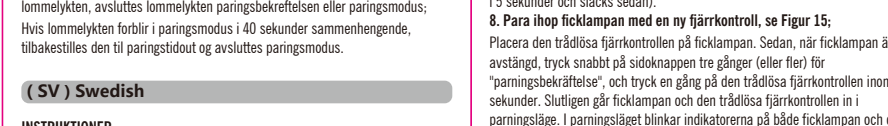

Figure 36

Press and hold



Figure 37

Press and hold

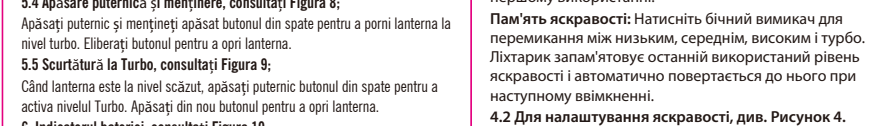

Figure 38

Press and hold

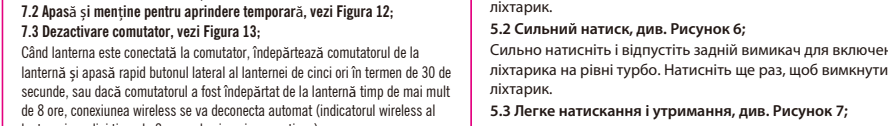

Figure 39

Press and hold

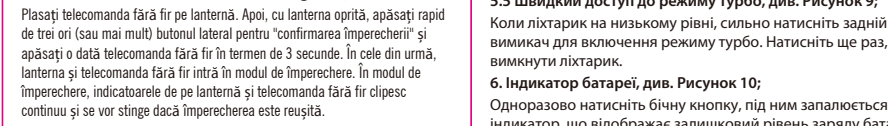

Figure 40

Press and hold

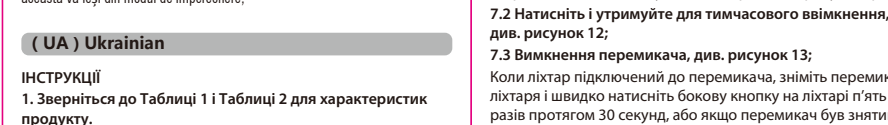

Figure 41

Press and hold

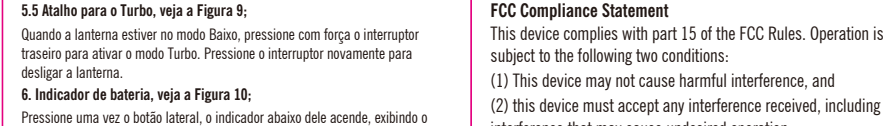

Figure 42

Press and hold

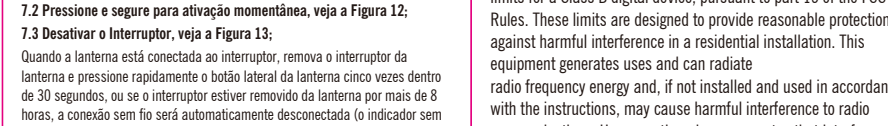

Figure 43

Press and hold

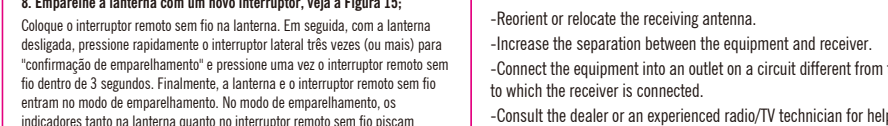

Figure 44

Press and hold

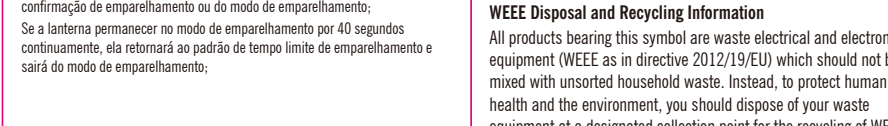

Figure 45

Press and hold

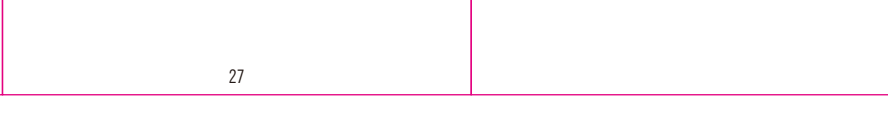

Figure 46

Press and hold

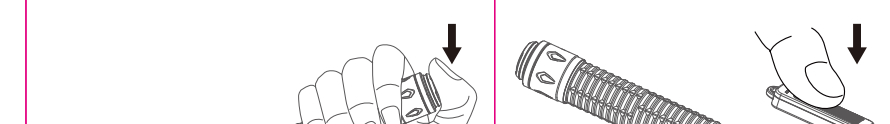

Figure 47

Press and hold

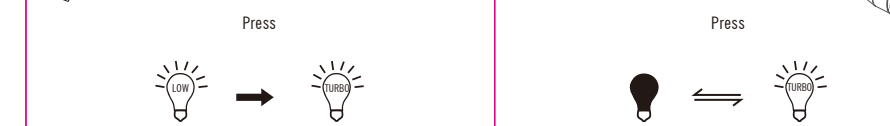

Figure 48

Press and hold

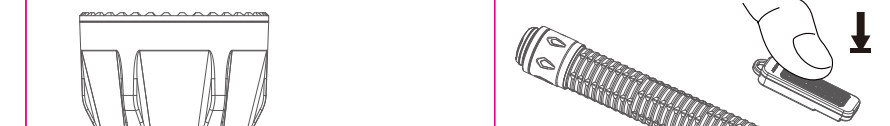

Figure 49

Press and hold



Figure 50

Press and hold



Figure 51

Press and hold

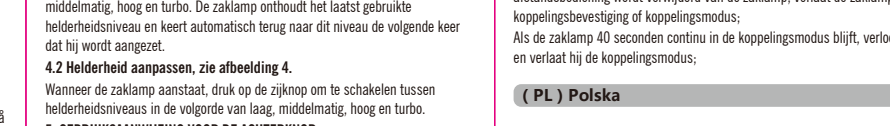

Figure 52

Press and hold

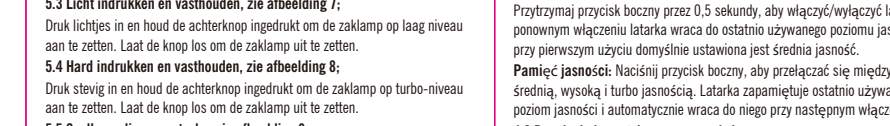

Figure 53

Press and hold

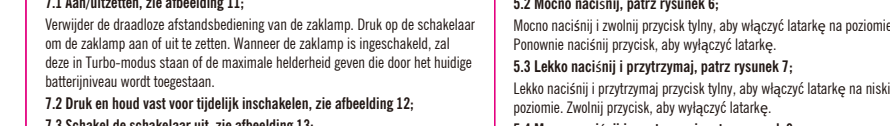

Figure 54

Press and hold

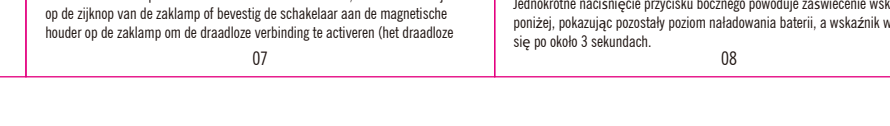

Figure 55

Press and hold

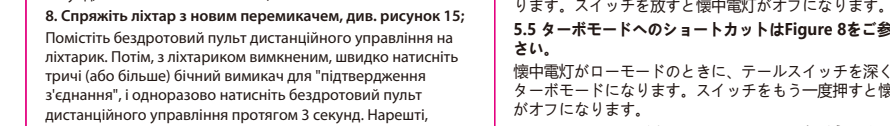

Figure 56

Press and hold

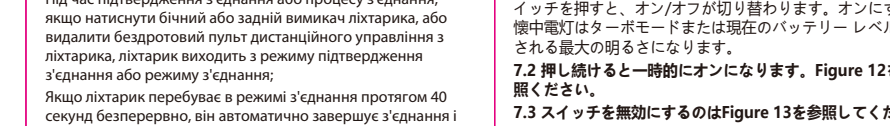

Figure 57

Press and hold

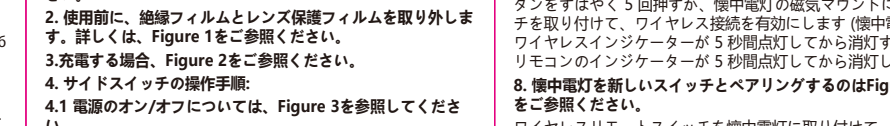

Figure 58

Press and hold

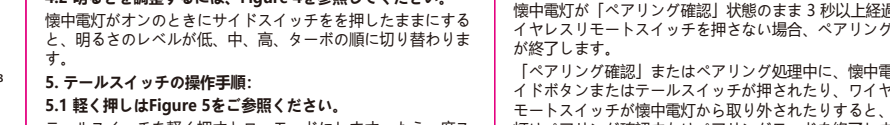

Figure 59

Press and hold

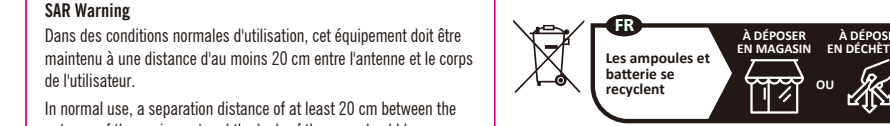

Figure 60

Press and hold

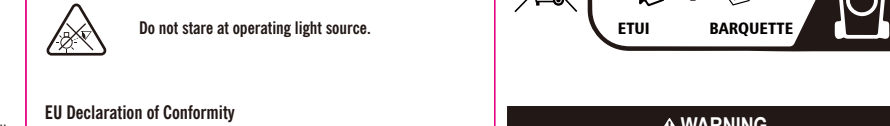

Figure 61

Press and hold

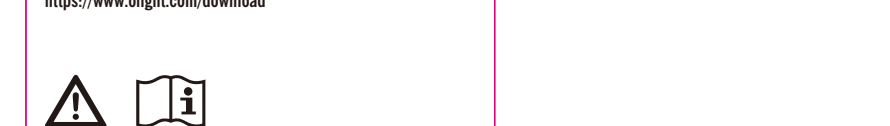

Figure 62

Press and hold

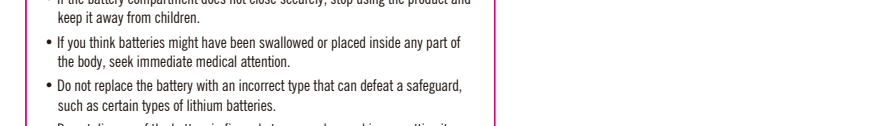

Figure 63

Press and hold

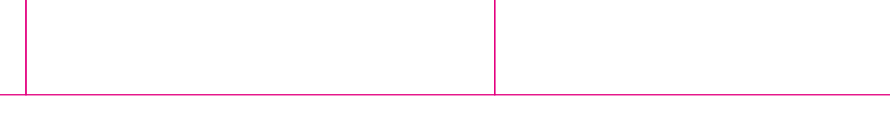

Figure 64

Press and hold

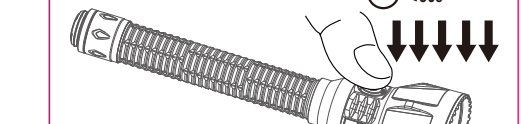

Figure 65

Press and hold

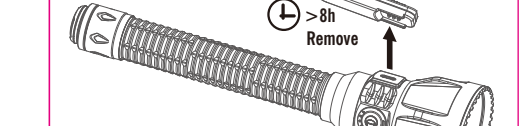

Figure 66

Press and hold

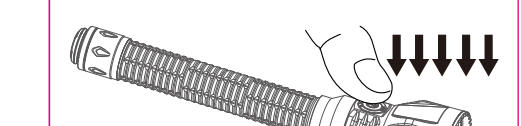

Figure 67

Press and hold

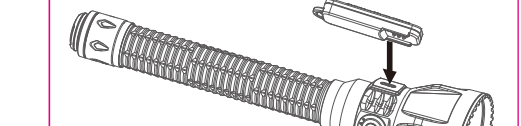

Figure 68

Press and hold

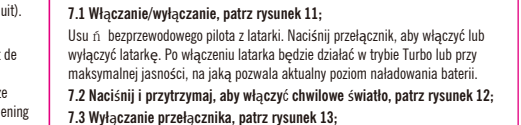

Figure 69

Press and hold

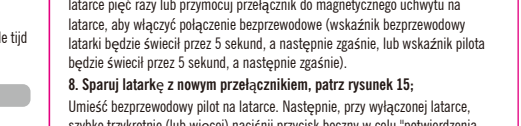

Figure 70

Press and hold

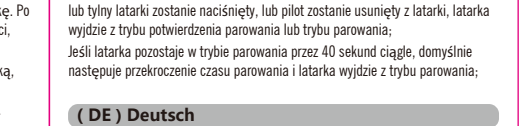

Figure 71

Press and hold

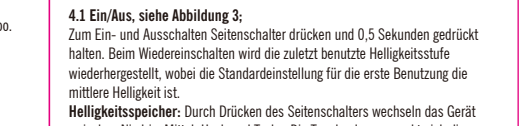

Figure 72

Press and hold

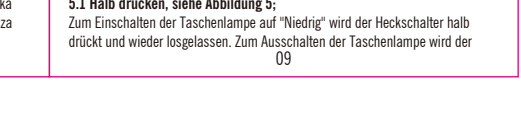

Figure 73

Press and hold

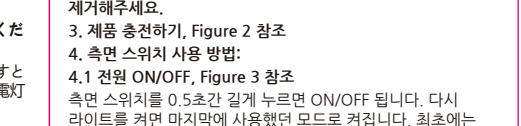

Figure 74

Press and hold

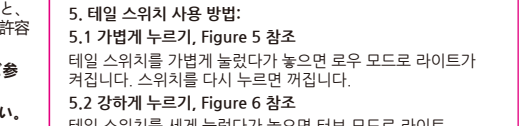

Figure 75

Press and hold

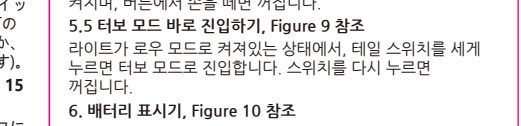

Figure 76

Press and hold

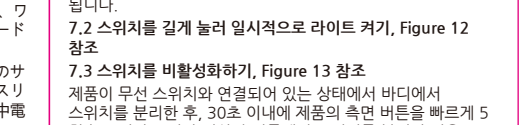

Figure 77

Press and hold



Figure 78