

Lithium Manganese Dioxide Battery

CR2430

■ Dimensions(mm)

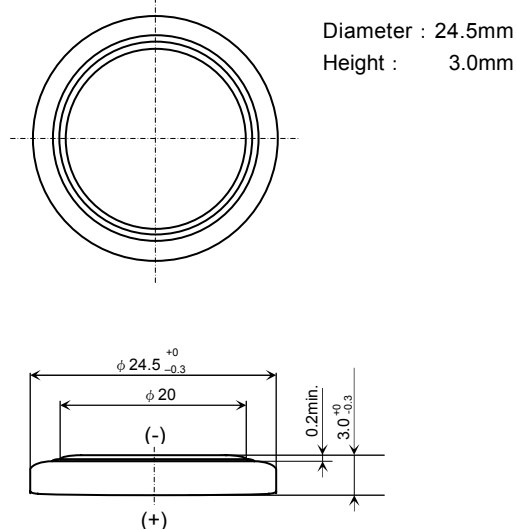

■ Specifications

Nominal Voltage	3V
Nominal Capacity (2.0V cutoff)	300mAh
Standard Discharge Current	0.2mA
Weight	4.3g

Applications

- Memory Back-up Power Source for SRAM or Real Time Clock (RTC)

■ Discharge Characteristics

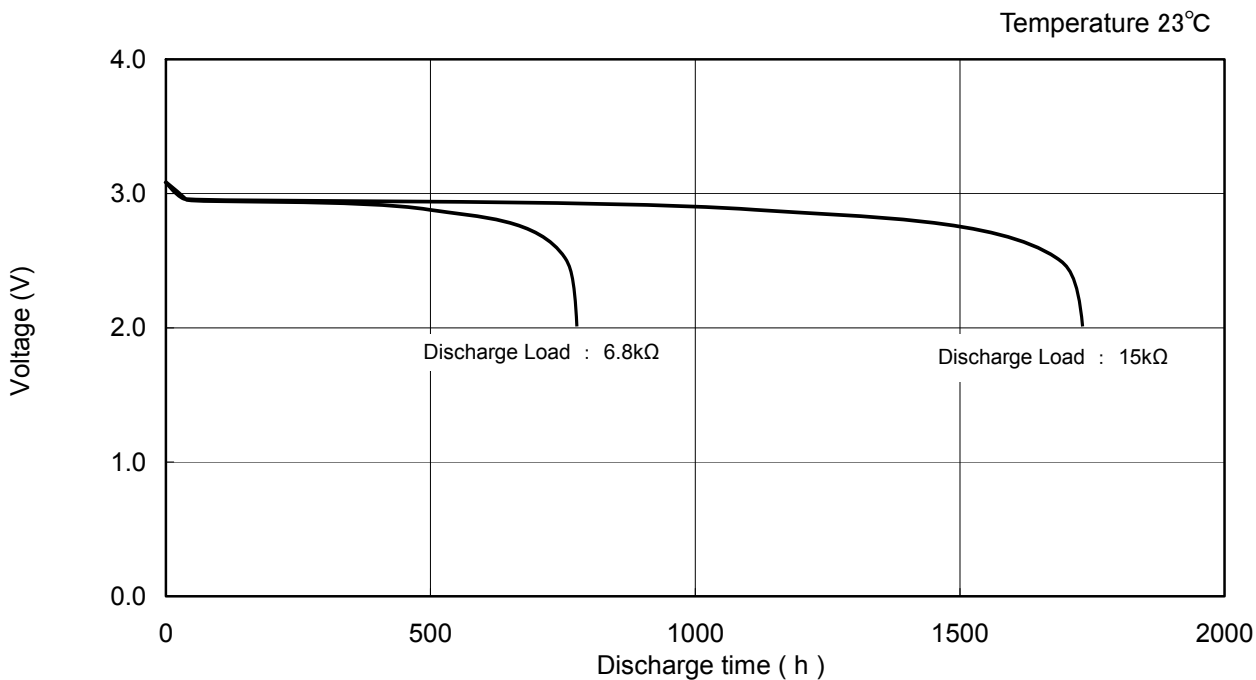

■ Discharge Characteristics on Load

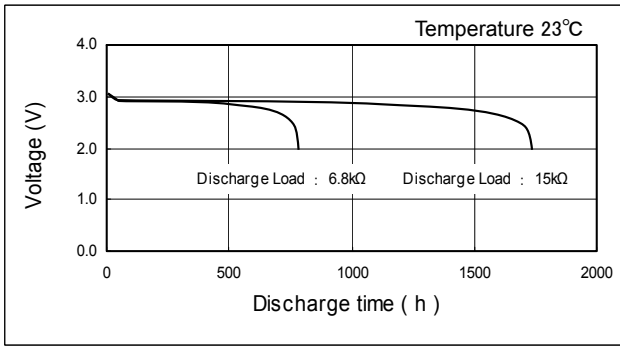

■ Discharge Characteristics on Temperature

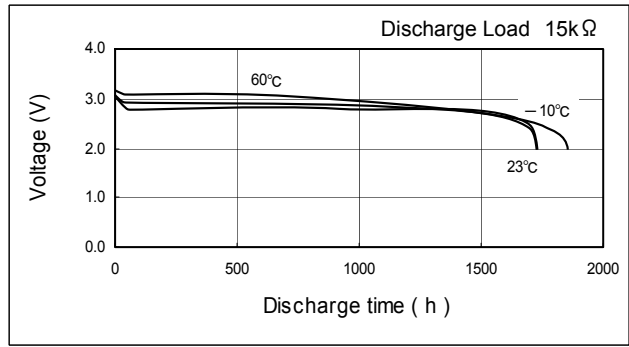

■ Discharge Load vs. Operation Voltage (Discharge depth 40%)

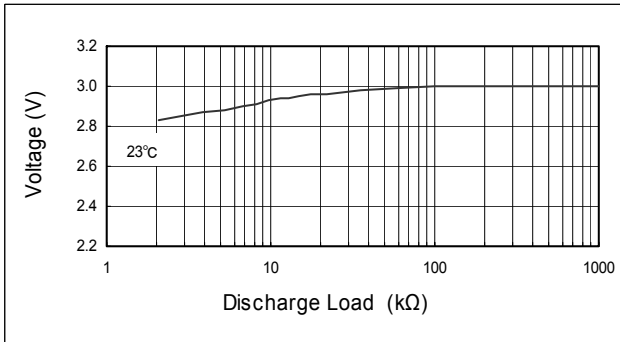

■ Discharge Load vs. Discharge Capacity

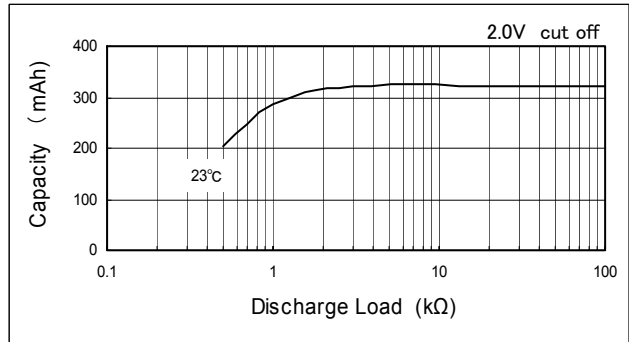

■ Discharge Characteristics on Pulse Load (Discharge depth 40%)

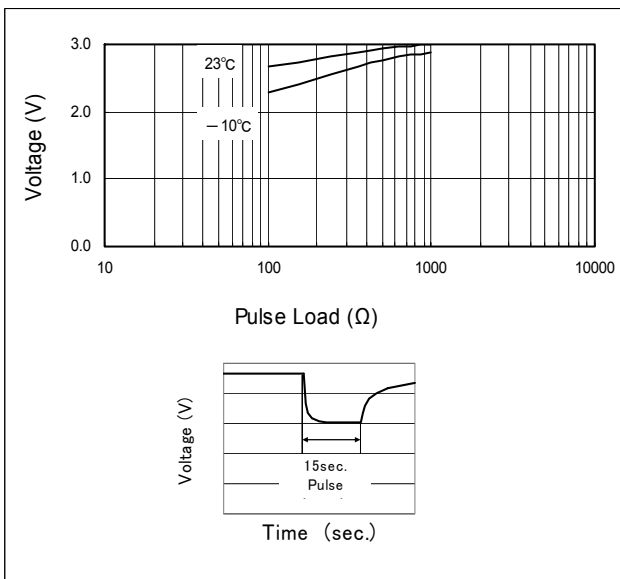

■ Storage Characteristics

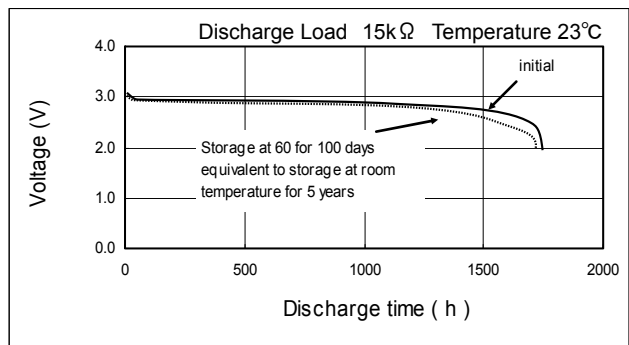

* These values are not guarantee.